



Karoliina Meurman
8 March 2018

AGEING STUDY ON SMOKE ALARMS

FINAL REPORT

Summary

The aim of the project led by the Finnish Safety and Chemicals Agency (Tukes) was to gain additional information on the functioning of ageing smoke alarms, to provide information on the results of the study, and to increase awareness of the need to replace old smoke alarms with new ones. Tukes is responsible for monitoring the compliance of new smoke alarms in the market, and this was not a market surveillance project.

For the project, Tukes asked the importers of smoke alarms and smoke detectors for information regarding the ageing of smoke alarms. Additional background material gathered included information on the functioning of smoke alarms in events of fire and in fatal fires in Finland, Sweden, USA and Britain. No previous research data was found on the smoke sensitivity of ageing smoke alarms.

Used smoke alarms were collected as donations for the project. Information collected on these smoke alarms included their location and maintenance details. Most of the donated smoke alarms were ionisation smoke alarms, as the first smoke alarms to enter the Finnish market were the ionisation type. Out of the donated smoke alarms, 70 were chosen for testing. They were aged between 2 and 33 years. Only smoke alarms with a working test button and a working alarm sound were chosen for testing. As a control for the smoke sensitivity of the old smoke alarms, eight new smoke alarms were also tested. Of the tested smoke alarms, 23 were optical and 55 were ionisation smoke alarms.

Smoke sensitivity was tested with two fires that simulated the smoke alarm standard. A smouldering pyrolysis wood fire produces white smoke slowly, while burning polyurethane produces dark smoke quickly. The tests were conducted in the fire theatre of the Emergency Services College.

The decibel levels of the smoke alarms were not tested, but based on perceived observations, the alarm volume of the most dirty and rusty and the oldest smoke alarms, in particular, was clearly weaker. In addition, large amounts of dirt and corroded components were found inside some smoke alarms.

The tested smoke alarms reacted to smoke, but there was great variation in alarm times. The functioning of the ionisation smoke alarms seemed to be more homogeneous, particularly in polyurethane fires.

The age-related changes observed in the project – the accumulation of dirt, changes in smoke sensitivity, corrosion, weaker alarm volume, and the impact they have on the functioning – support the need to replace old smoke alarms as instructed by the manufacturer. As the project was the first of its kind, many issues worth further studies were identified. The project will be followed by a further project.

The project was realised in cooperation with Finance Finland, the Central Association of Chimney Sweeps, Safety Investigation Authority, Emergency Services College, Ministry of the Interior, Finnish Association of Fire Officers, Finnish National Rescue Association and the Partnership Network of Finnish Rescue Services. The project began in spring 2017 and it was completed in March 2018.

Table of contents

1. Introduction.....	3
2. Background and project plan	3
2.1 Background.....	3
2.2 Project plan.....	4
3. Operating principle of a smoke alarm	4
3.1 Optical smoke alarm.....	4
3.2 Ionisation smoke alarm	5
4. Previous research data and statistics	6
4.1 Ageing of smoke alarms	6
4.2 Functioning of smoke alarms in fires.....	7
5. Reasons related to ageing smoke alarms	8
6. Smoke sensitivity testing.....	9
6.1 Smoke alarms selected for testing	9
6.2 Testing arrangements.....	11
6.3 Results	16
6.4 Dirt and corrosion in old smoke alarms.....	19
6.5 Volume level.....	21
7. Conclusions.....	21
7.1 Conclusions drawn from the project results	21
7.2 Evaluation of the project and further action.....	22
References	23
Appendix 1.....	24

1. Introduction

The Finnish Safety and Chemical Agency (Tukes) is responsible for monitoring the compliance of new smoke alarms sold in Finland. The technical features of smoke alarms must comply with the requirements of the standard *SFS-EN 14604 Smoke Alarms*. Market surveillance measures include carrying out smoke sensitivity tests on new smoke alarms on the market, inspecting documents, and monitoring the European Union's RAPEX system that is used to exchange information on unsafe consumer products.

The public is actively informed about the need to buy and maintain a smoke alarm (changing the battery and monthly testing). However, the operating life of a smoke alarm is limited, and according to the standard, the replacement date recommended by the manufacturer must be marked on the smoke alarm. In general, manufacturers define the operating life to be 5–10 years from the production date of the smoke alarm.

2. Background and project plan

2.1 Background

According to the results of the market surveillance projects carried out by Tukes, around 83% of tested, new smoke alarm models reacted to smoke in the required manner, and according to a survey conducted by the Ministry of the Interior in 2014, 95% of households have a smoke alarm. However, according to the PRONTO database (Rescue Services' resource and accident statistics) maintained by the Emergency Services College, in 2009–2016, 18% of building fires involved an inoperative smoke alarm. The real figure may be higher, as a large portion of the data on building fires in PRONTO does not include information on the functioning of a smoke alarm.

A functioning smoke alarm is vital in the early detection of a fire and in escaping from a fire. Today, many materials used in residential buildings, such as pieces of furniture, contain plastic compounds. In terms of risk in fire, plastics are equal to liquid fuel, and they have a significant effect on a fire within a room by causing a backdraft (ignition of fire gases) to occur earlier [1]. According to a study conducted by the Emergency Services College [2], the loss accrual in a fire within a room is at the highest a few minutes after the ignition of fire. Similarly, the first few minutes are crucial in terms of people being rescued or able to escape from a fire.

The aims of the Ageing study on smoke alarms project were to gain information on the reliability (smoke sensitivity) of old smoke alarms, to share the results of the study, and to increase awareness of the need to replace old smoke alarms. The study also explored the reasons in the functioning of an old smoke alarm that would explain the notable share of inoperative smoke alarms in fires. Another aim was to utilise the results when updating the educational material.

2.2 Project plan

The project plan included taking the following actions:

- gather old smoke alarms as donations with the help of partners and test them in the fire theatre of the Emergency Services College
- ask the major operators in the field of smoke alarms and smoke detectors in Finland whether their product development and/or quality control includes clarifying the ageing of a smoke alarm (smoke detector), and how the manufacturers determine the recommended operating life
- ask the authorities in Sweden, Norway and Denmark whether a similar survey has been carried out in these countries
- search the PRONTO for statistics on the functioning of smoke alarms in fires
- prepare a final report and share information on the issue.

Old smoke alarms were gathered with the help of the employees of the agencies involved in the project and as donations from the customers of chimney sweeps. Owners of the donated smoke alarms were responsible for buying new smoke alarms and for fitting them appropriately. For each donated smoke alarm, the owners were asked to complete a form including details on the location and maintenance of a smoke alarm (Appendix 1).

Researchers also asked for research data from the NFPA (National Fire Protection Association) in the US. In addition to the initial plans, research data was also gathered from Sweden, the US and Britain.

3. Operating principle of a smoke alarm

A smoke alarm is a device that detects smoke and sounds an acoustic alarm. There are two types of smoke alarms: optical and ionisation smoke alarms. For a long time, all the smoke alarms on the market were the ionisation type. The first optical smoke alarms entered the market at the beginning of the 2000s, and today, according to a quantity survey conducted by Tukes, more than 80% of the smoke alarms entering the market are optical.

3.1 Optical smoke alarm

The operation of an optical smoke alarm is based on measuring the light emitted by a source of light inside the smoke alarm. Optical smoke alarms are divided into two types according to their operating principle of either scattered light or transmitted light. In a smoke alarm that operates on the principle of scattered light, if there is a fire, light beams emitted by a LED are reflected from particles of smoke onto a photodiode. In a light-transmission-based smoke alarm, the LED emits beams of light directly onto the photodiode. If there is a fire, particles of smoke will block the beams of light partly or completely from reaching the photodiode, which will then register this change.

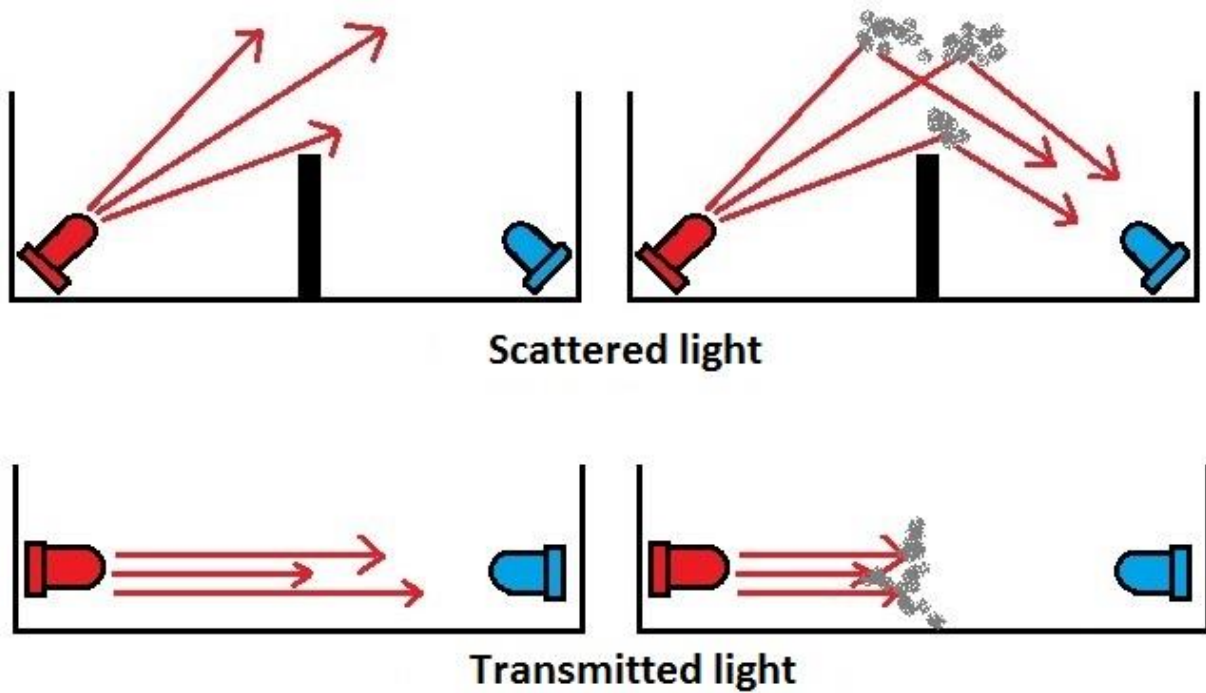

Figure 1. Operating principle of an optical smoke alarm

3.2 Ionisation smoke alarm

An ionisation smoke alarm has a small americium-241 radiation source. The smoke alarm has two energised metal sheets with the radioactive source emitting radiation between them. The radiation emitted by the radioactive source changes the electrical conductivity of air. As smoke enters the smoke alarm, the radiation is partly absorbed in the particles of smoke, the electrical conductivity of air changes, and the alarm is activated.

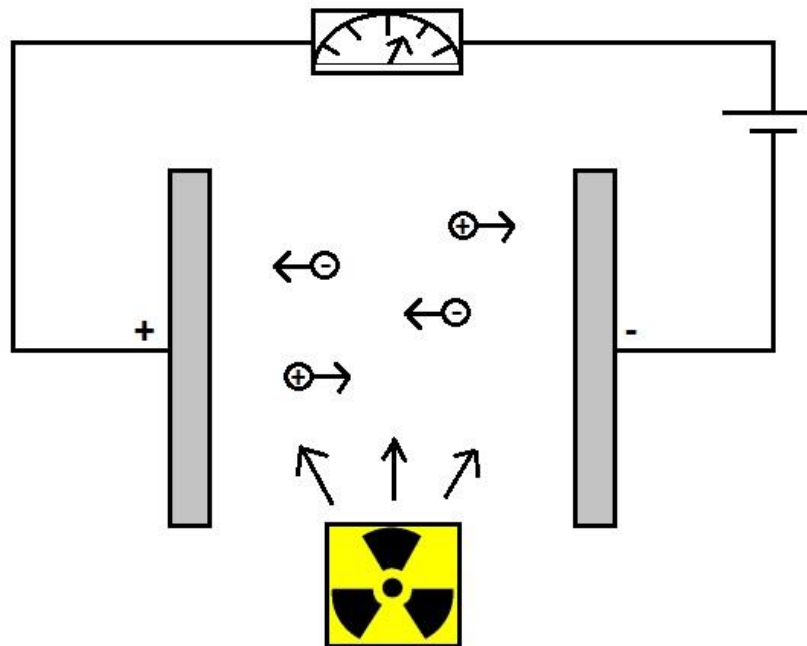

Figure 2. Operating principle of an ionisation smoke alarm (no alarm). In a fire, some radiation is absorbed in the particles of smoke, causing the electrical conductivity of air to change

4. Previous research data and statistics

4.1 Ageing of smoke alarms

No research was found on the ageing of smoke alarms that involved testing old smoke alarms with real smoke. Research has focused on studying the durability of batteries and/or studying the functioning of a smoke alarm by pressing the test button. Pressing the test button will only test the functioning of the smoke alarm battery and the alarm sound.

In 1999–2009, Tukes (Risto Raitio) undertook a project that studied the functioning of smoke alarms operating on a ten-year battery or battery cell. The project involved eight ionisation smoke alarms. The smoke alarms were tested for a period of ten years by pressing the test button once a month. In general, the power source of the smoke alarms in the ten-year tests lasted the time specified in the operating instructions. Finally, the smoke alarms were tested with Smokesabre test gas and with Splintax smoke matches. Roughly one in two smoke alarms reacted to the test gas, but they all reacted to the smoke from the smoke matches.

A Norwegian literary study [3] was conducted on smoke alarms in residential buildings. The study collated research data and publications published after 2000 that relate to the functioning of the modern smoke alarms, the reliability of smoke alarms, and the placing of smoke alarms. The research was carried out by SINTEF (a Norwegian research organisation).

In the US, a ten-year project on smoke alarms [4] was carried out in 1998–2008 that focused on the durability of lithium batteries. The research was carried out by NCHH (National Center for Healthy Housing). 427 households were selected for the research and new, lithium-battery-operated smoke alarms were fitted in the homes. The smoke alarms were tested as they were fitted by pressing the test button. The condition of the smoke alarms was tested again after 8–10 years. This provided information on the functioning of smoke alarms (601 items) in 384 households. According to the research, 33% of the smoke alarms were working, 37% were lost or missing, and 30% were not working.

The following reasons were given for inoperative smoke alarms: In 43% the battery did not work, 17% had no battery, 13% of the smoke alarms were damaged, and 27% gave another reason (such as reason unknown, missing parts, or accumulation of dust). Factors affecting the inoperativity of smoke alarms included fitting the device in the kitchen and the make of the smoke alarm.

The statement in the final results was that smoke alarms with lithium batteries ('the ten-year batteries') should be manufactured in a way that prevents the users from replacing the battery. Another finding was that the function indicating the end of the battery life inside a smoke alarm would increase the reliability of smoke alarms. The smoke sensitivity of smoke alarms was not tested in the study.

4.2 Functioning of smoke alarms in fires

The functioning of smoke alarms in fires was investigated in dwelling fires, and separately in fatal dwelling fires in Finland, Sweden, the US and Britain. The statistics were similar in all countries. The percentages were calculated from data that included information on the functioning of a smoke alarm.

The PRONTO database provided the following statistical data on fires and fire-related fatalities in Finland:

- Fires (y. 2009–2016)
 - o functioning smoke alarm 44%
 - o inoperative smoke alarm 6%
 - o no time for the smoke alarm to work 12%
 - o no smoke alarm 38%
- Fire-related fatalities (y. 2007–2016)
 - o functioning smoke alarm 27 %
 - o inoperative smoke alarm 15 %
 - o no smoke alarm 58 %

In Sweden, MSB (Myndigheten för samhällsskydd och beredskap) provided the researchers with the following statistical data:

- Fires (y. 2009-2015)
 - o functioning smoke alarm 46 %
 - o inoperative smoke alarm 4 %
 - o there was a smoke alarm, but the functioning is unknown 12%
 - o no smoke alarm 38%

- Fire-related fatalities (y. 2009-2015)
 - o functioning smoke alarm 34%
 - o inoperative smoke alarm 9 %
 - o there was a smoke alarm, but the functioning is unknown 17 %
 - o no smoke alarm 41 %

In Britain, the following statistical data on fires and fire-related deaths is available for 2010–2017 [5]:

- Fires
 - o functioning smoke alarm 39 %
 - o inoperative smoke alarm 31 %
 - o no smoke alarm 31 %
- Fire-related fatalities
 - o functioning smoke alarm 26 %
 - o inoperative smoke alarm 39 %
 - o no smoke alarm 36 %

In addition to dwellings, the statistics for Britain include outbuildings and other such structures. In the above list, the item of "inoperative smoke alarm" includes the items *smoke alarm present, operated but did not sound the alarm*, and *present, but did not operate*.

The American NFPA has collected the following statistical data [6] for 2009–2013 on fires and fire-related fatalities in the US:

- Fires
 - o functioning smoke alarm 53 %
 - o inoperative smoke alarm 8 %
 - o no time for the smoke alarm to work 12%
 - o no smoke alarm 27 %
- Fire-related fatalities
 - o functioning smoke alarm 40 %
 - o inoperative smoke alarm 21 %
 - o no time for the smoke alarm to work 1 %
 - o no smoke alarm 38%

In the US, in fires with a working smoke alarm and sufficient smoke formation, the most common reason (46%) for a inoperative smoke alarm was a missing or disconnected battery, followed by (24%) a inoperative battery. When combined, these figures come very close to the PRONTO statistics for Finland: in fires in which smoke alarms should have worked, the most common reason (67%) was a missing or inoperative battery.

5. Reasons related to ageing smoke alarms

According to information received from importers of smoke alarms and smoke detectors, product development work also includes research regarding the ageing of smoke alarms. The primary reasons for

the ageing of smoke alarms include dirt gathering in the detection chamber and the electronic components of the smoke alarm, and the ageing of the components.

In time, smoke alarms accumulate dust, insects, nicotine and oils. Depending of the type of smoke alarm, this may cause increased sensitivity, decreased sensitivity, or inoperativity. In time, false and unnecessary alarms may also lead to people removing the smoke alarm or the battery.

Electronic components do not last forever. In addition to dirt, the ageing of components depends on the load of the circuit. Gradual changes in the LED transmitter/receiver inside optical smoke alarms may alter and hinder their ability to detect smoke.

Smoke alarms connected to the main electricity source are subjected to electromagnetic interferences that may, in time, enhance the ageing of certain components.

The surrounding conditions of a smoke alarm have an essential impact on how much dirt is gathered in it. The most commonly recommended ten-year interval for replacing a smoke alarm is considered justified with regard to all the factors that affect the ageing of smoke alarms.

6. Smoke sensitivity testing

6.1 Smoke alarms selected for testing

Out of the donated smoke alarms, 70 were chosen for testing; 17 were optical and 53 were ionisation smoke alarms. Most of the donated smoke alarms were the ionisation type. According to a survey conducted by Tukes in 2016, around 80% of the smoke alarms on the market are optical. This means that the proportion of the types among the donated smoke alarms was significantly different from the proportion on the current market. The first smoke alarms to enter the Finnish market were all ionisation smoke alarms, which explains their larger proportion among the donated, old smoke alarms.



Figure 3. Donated smoke alarms

The smoke alarms selected for testing were aged between 2 and 33 years. The age was calculated from the manufacturing date marked on the smoke alarms. Only smoke alarms with a working test button were selected for testing. As a control for the smoke sensitivity of the old smoke alarms, eight new smoke alarms were also tested; six optical and two ionisation smoke alarms. Table 1 shows the distribution of the smoke alarms based on their age in five-year intervals.

Table 1. Age distribution of the smoke alarms tested

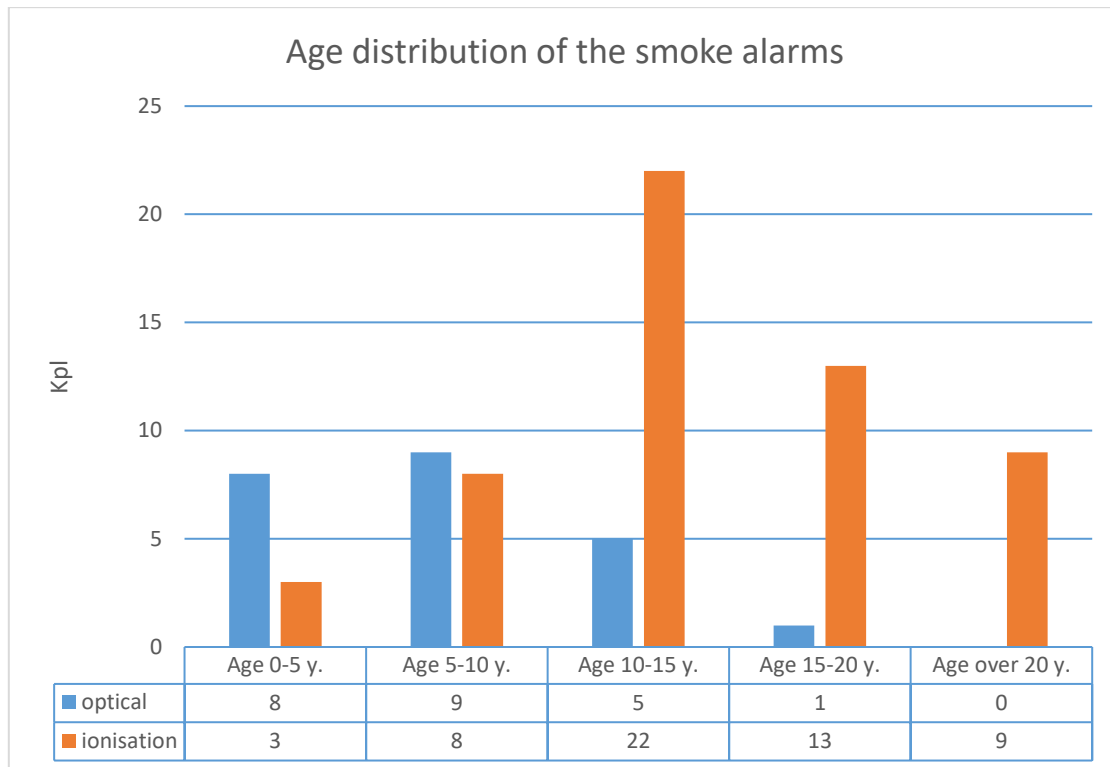

6.2 Testing arrangements

The smoke sensitivity of old smoke alarms was tested in the fire theatre of the Emergency Services College in November and December 2017. The smoke alarm standard EN 14604 defines four test fires that produce white or dark smoke depending on the burning material. The test fires defined in the standard are smouldering pyrolysis wood, flaming plastics (polyurethane), glowing smouldering cotton, and flaming liquid (n-heptane) fires. The fires selected for the ageing smoke alarm study were the wood and polyurethane, as they represent a white and a dark smoke and as materials found in a dwelling are likely to contain wood and/or plastic compounds. Because the ageing smoke alarm study was not a market surveillance project, the smoke sensitivity tests were not conducted in accordance to the standard but rather as an adaptation of the standard.

Testing arrangements in the fire theatre of the Emergency Services College were as follows: The dimensions of the test areas were 7.8 x 5.4 x 2.5 m (w x l x h). The estimated temperature of the room prior to test fires was +20°C. The smoke alarms were installed on the ceiling 3 metres away from the test fire. The test fire was on top of a cooker at the height of 90 cm.

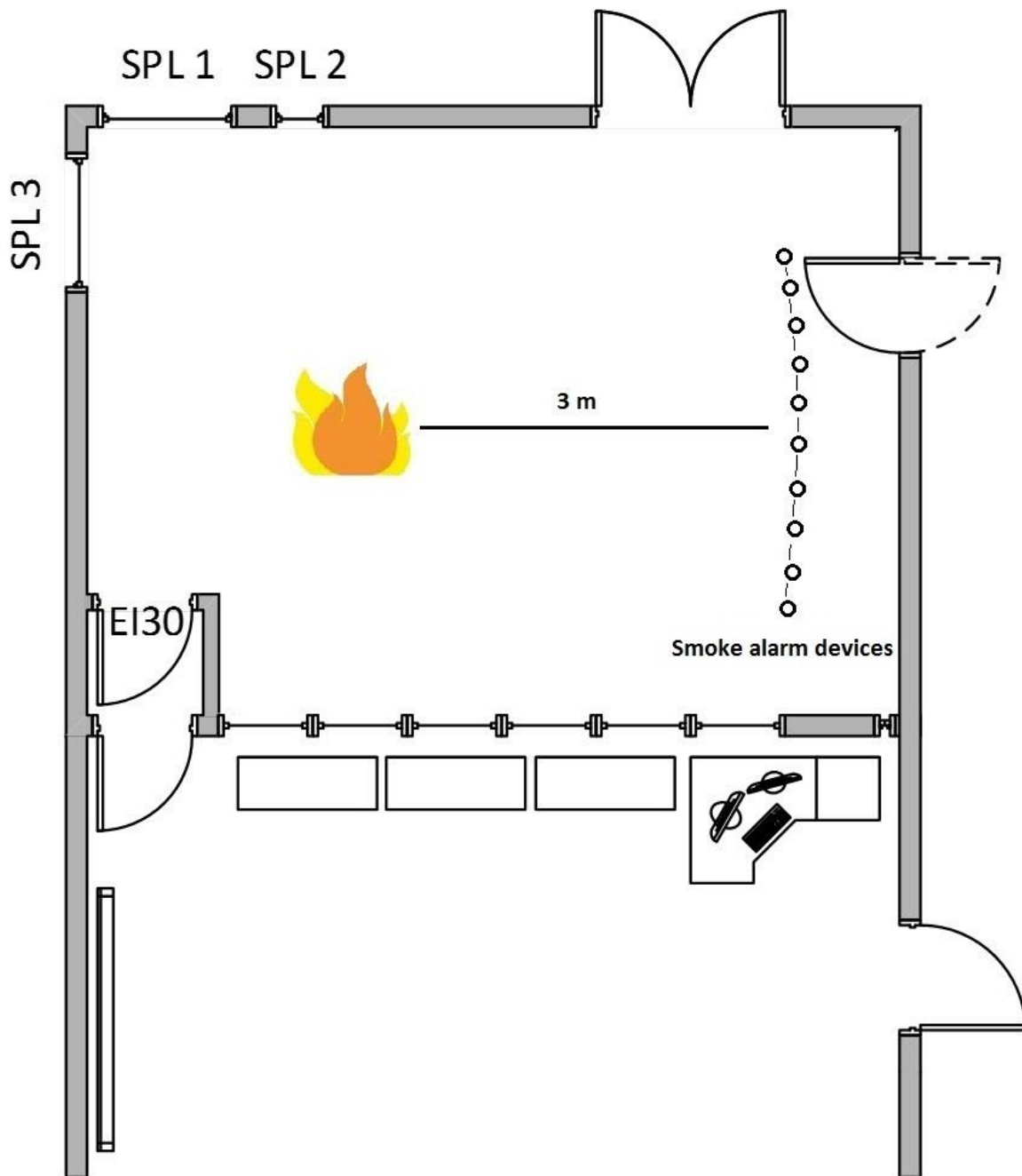

Figure 4. Floor plan of the test arrangements in the fire theatre

The smoke alarms were tested in batches of ten. The samples were prepared for measuring by soldering a voltage monitor to the speaker circuit and by connecting the monitor to an A/D converter. The converter was connected to the DasyLab software. A program was built in the DasyLab software for monitoring and logging the voltage monitor and the K-type thermocouple sensors at one-second intervals. Each measuring circuit was tested with a circuit analyser to make sure that the soldering was working. The measurements generated real-time data that was recorded with the DasyLab software once every second throughout the testing process.

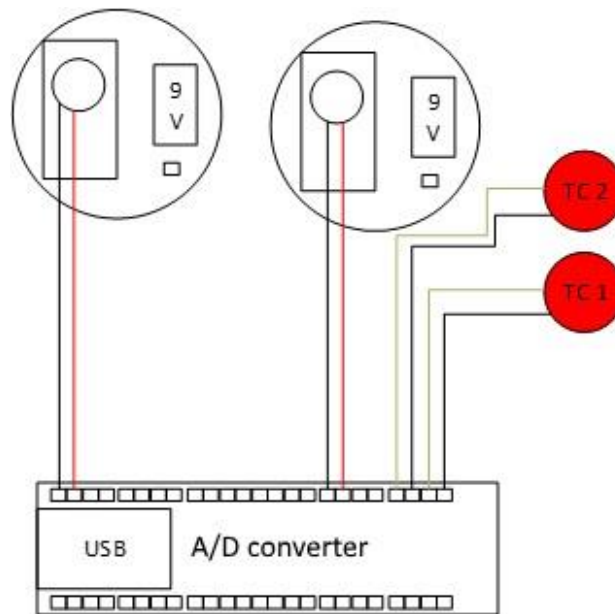

Figure 5. DasyLab measuring set up: TC1 = temperature of the hotplate, TC2 = temperature of the room
(image: Emergency Services College)

The purpose of the voltage monitor was to measure the change in voltage in the speaker circuit, i.e. the moment the smoke alarm goes off. Before the first test burn in each series, the operation of the data collecting system (change in voltage) was tested by pressing the test button on the smoke alarms.



Figure 6. Testing arrangements in the fire theatre

In the first test fire, pine wood blocks were placed on top of a hot plate (2.2 kW). The plate was switched on, and as its temperature reached 160°C, smoke began to form. In two tests, the wood blocks caught fire, and the fire was put out since ignition reduced the formation of smoke considerably. At the earliest, the test was stopped 10–12 minutes after switching on the hot plate, or after all the smoke alarms had reacted to the smoke. The room was aired out, which caused all but one smoke alarms to stop sounding the alarm.

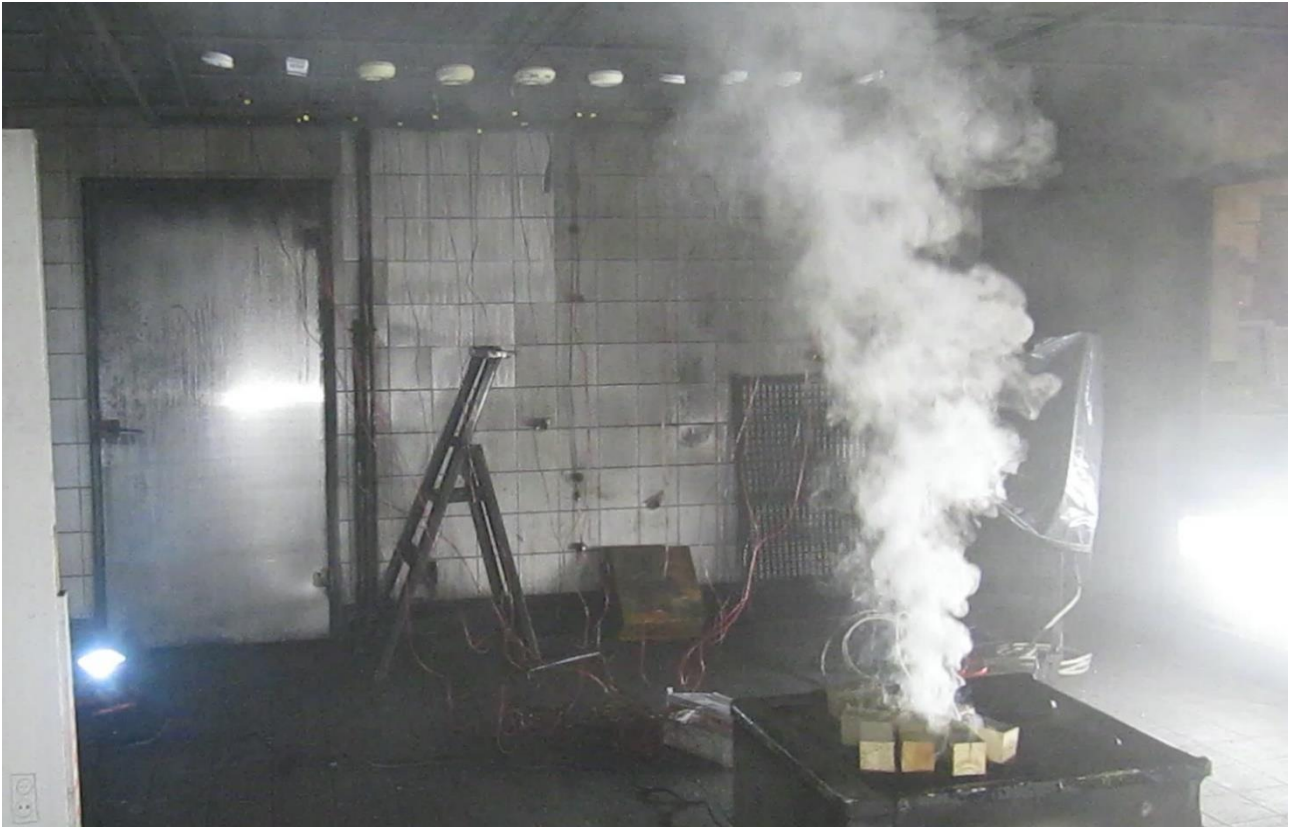

Figure 7. Smouldering pyrolysis wood fire

After airing out the room, a 50 x 50 x 5.5 cm polyurethane board was placed on top of the cooker and it was lit with a small amount of burning solvent. The polyurethane fire produced considerably more smoke faster than the wood fire. The smoke was also dark in colour.



Figure 8. Polyurethane board after ignition



Figure 9. Test room in the fire theatre during the polyurethane fire

After completion of both test fires, the room was aired out and the same procedure was repeated on the next series of smoke alarms in the test.

6.3 Results

In smoke sensitivity tests conducted in accordance with the smoke alarm standard EN 14604, the tested smoke alarms must react before the defined end of test, for the test to be approved. Factors affecting the result include density of smoke, change in temperature, and time. The ageing study on smoke alarms project did not involve an assessment in accordance with the standard; rather, the functioning was assessed in relation to alarm time and age.

The formation of smoke depended largely on the burning material: The smouldering pyrolysis wood fire produced smoke slowly and the smoke also spread in the room slowly. The polyurethane fire produced smoke very quickly and the smoke spread faster and more evenly than in the wood fire.

One of the optical smoke alarms was faulty or possibly damaged during the preparation phase prior to testing. For this reason, its results were omitted. The rest of the smoke alarms reacted to smoke in a manner that enabled the testers to determine a precise reference time for the start of the alarm sound.

Table 2 shows the alarm time of each smoke alarm as a function of age in the wood fire, and Table 3 shows the same data for the polyurethane fire. The graphs for optical and ionisation smoke alarms are shown in different colours.

Table 2. Alarm time of a smoke alarm as a function of age in a smouldering pyrolysis wood fire

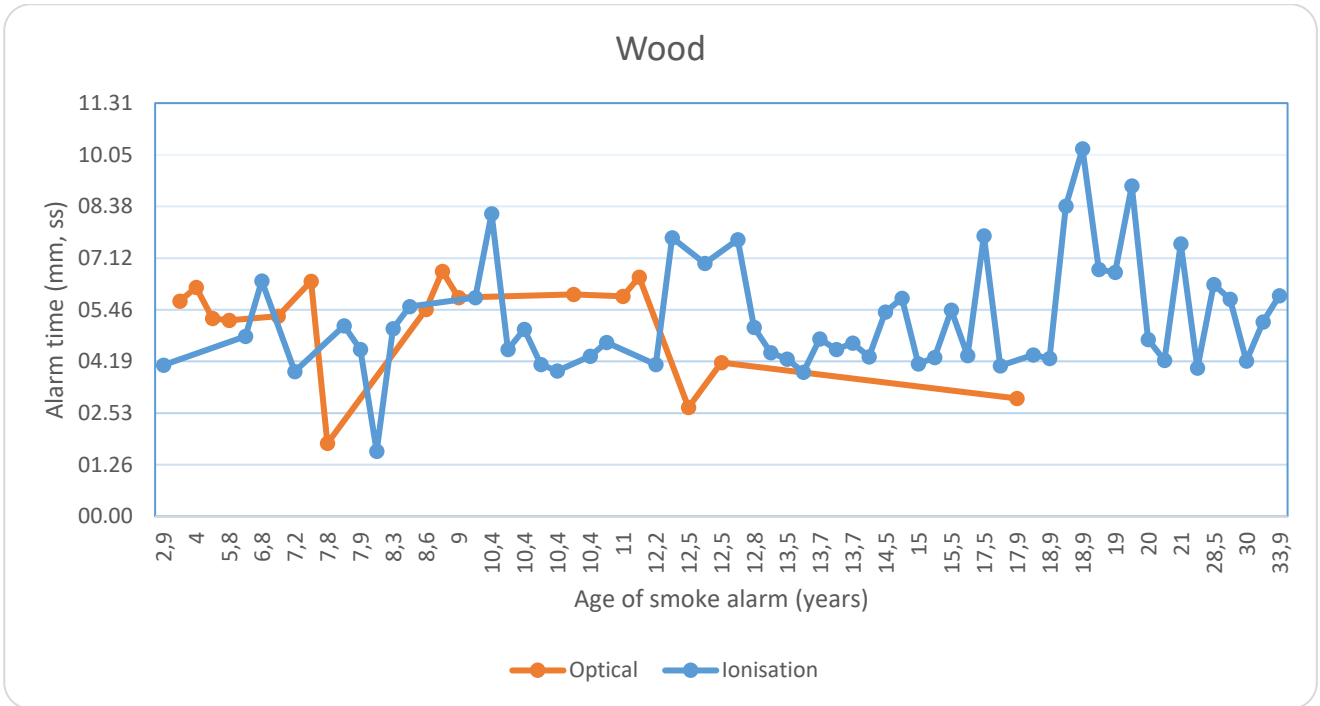
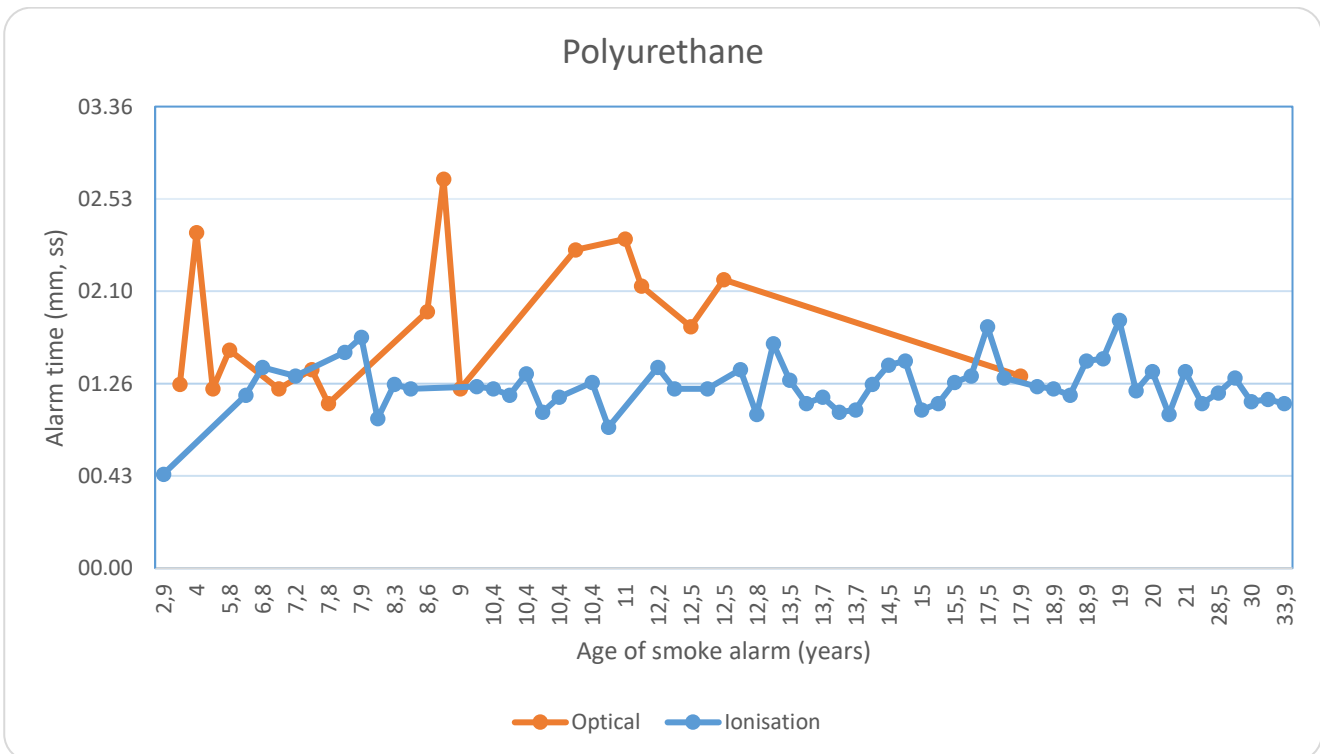

Table 3. Alarm time of a smoke alarm as a function of age in a polyurethane fire



Inspection of the wood fire graph (Table 2) indicates that reaction times varied significantly in both smoke alarm types, which can partly be explained by the slow formulation and more uneven spreading of smoke.

However, in the polyurethane fire (Table 3), there is significant variation in the reaction times of optical smoke alarms, while the reactions of the ionisation smoke alarms in the polyurethane fire seemed to be more homogeneous. Reaction times became a little slower with age, which can be explained by accumulation of dirt.

The tables below show the division of the smoke alarms according to age (0–5 y., 5–10 y., etc.) and a calculated average alarm time for each age group. Calculations were also made for the average alarm times of the new smoke alarms.

Table 4. Average alarm times

OPTICAL				IONISATION				NEW			
Age / y	n	Wood	Polyurethane	Age / y	n	Wood	Polyurethane		n	Wood	Polyurethane
0-5	8	0:06:16	00:02:14	0-5	3	00:04:22	00:01:30	Optical	6	00:06:26	00:02:30
5-10	9	00:06:23	00:01:57	5-10	8	00:04:51	00:01:29	Ionisation	2	00:04:42	00:01:53
10-15	5	00:05:26	00:02:24	10-15	22	00:05:22	00:01:25				
15-20	1	00:03:17	00:01:30	15-20	13	00:06:21	00:01:29				
				20–	9	00:05:21	00:01:21				

The alarm times of the new smoke alarms were slightly longer than those of the old ones. However, the sample of new smoke alarms was too small to draw any clear conclusions.

The project did not investigate whether the tested optical smoke alarms operated on the principle of scattered light or light transmission. Technical differences might explain why dirt causes some optical smoke alarms to become more sensitive and some less sensitive. With regard to ionisation smoke alarms, dirt is most likely to make the smoke alarm less sensitive. This was also indicated in the smoke sensitivity tests conducted.

The location of the smoke alarm or having a fireplace in the same location did not seem to have an impact on the alarm time.

The smoke alarms were sooty after the test fires. Soot was gathered near the buzzer, in particular, due to the sounding of the alarm (vibration caused by the speaker).



Figure 10. Dirt near the buzzer after testing

6.4 Dirt and corrosion in old smoke alarms

Before testing, the smoke alarms were opened. Some smoke alarms were observed to be very dirty inside. The most dirt was found inside the oldest smoke alarms. Corrosion was found on metal components perhaps due to uneven humidity conditions (holiday homes).

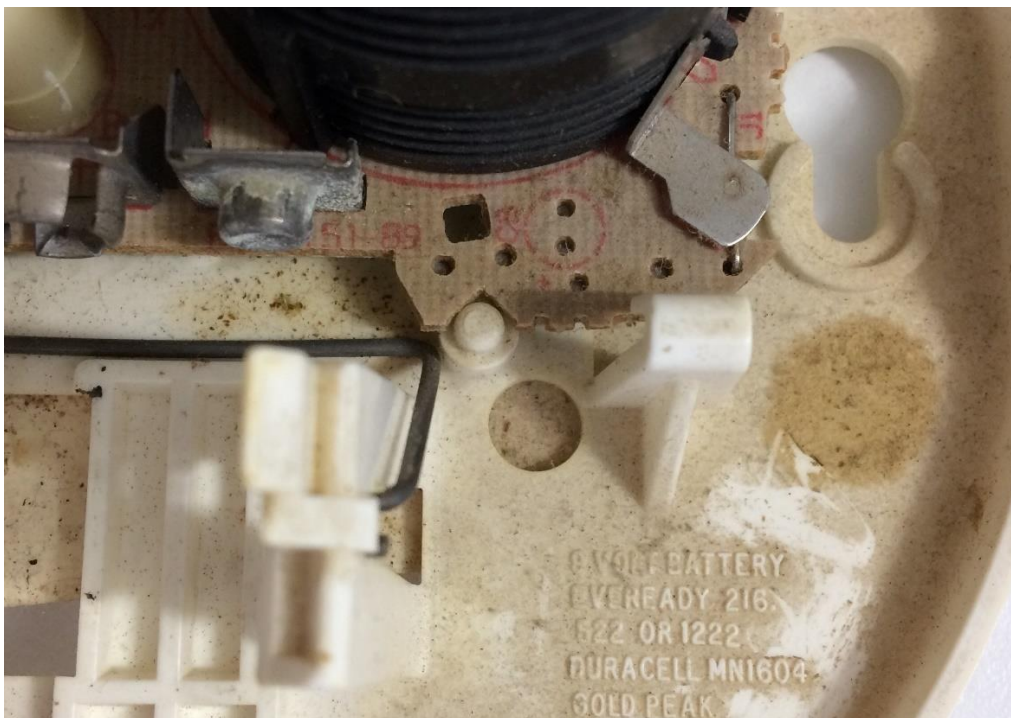

Figure 11. Dirt inside a smoke alarm

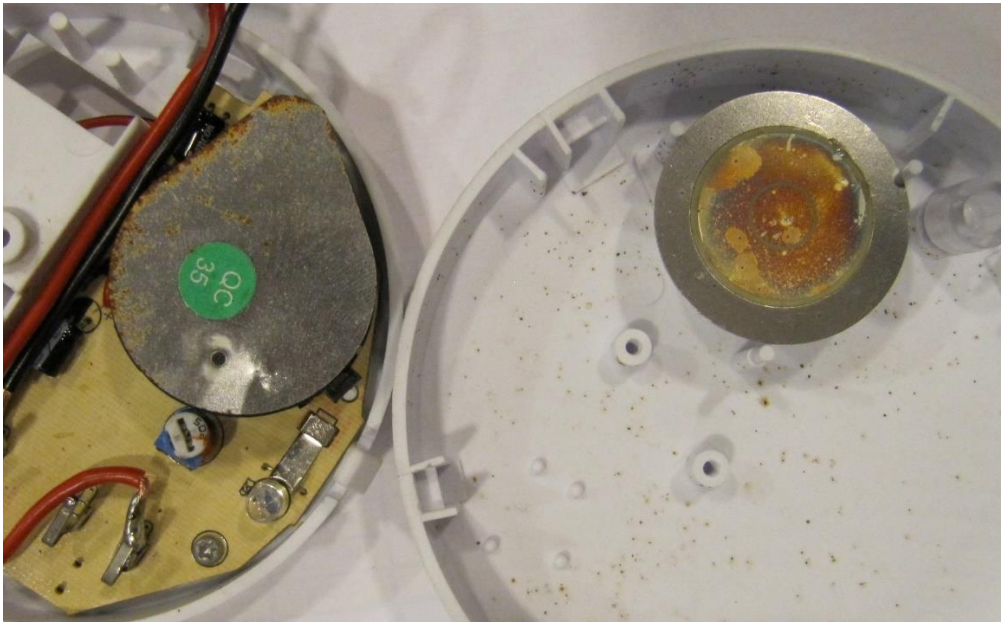

Figure 12. Dirt and corrosion inside a smoke alarm placed in a holiday home. On the left, a corroded detection chamber cover and on the right, a corroded buzzer.

One of the smoke alarms began to sound the alarm after the battery was connected. A dead spider was found inside this smoke alarm.

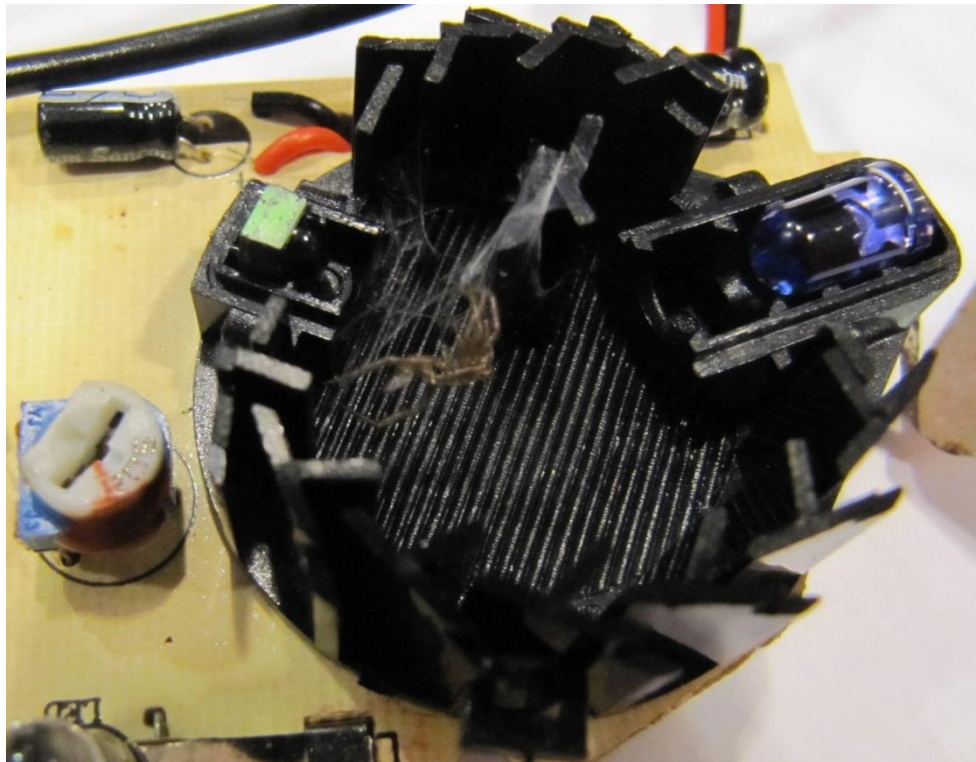

Figure 13. A dead spider inside the detection chamber of an optical smoke alarm

6.5 Volume level

Precise decibel levels of the volume were not measured, but when testing the alarm sound, it was clearly audible that the volume levels of the old smoke alarms were not equal or comparable to the volume levels of the new smoke alarms. The (metal) buzzer plate in certain smoke alarms was corroded and/or dirty, which lowered the volume level. The oldest smoke alarms, particularly those with dirty or corroded buzzers, had the lowest volume levels and more 'buzzing' sounds.

7. Conclusions

When inspecting the results, one should bear in mind that the smoke alarms donated for testing were working in terms of the alarm sound. No clearly faulty smoke alarms were selected for testing.

The sample of optical smoke alarms is too small to draw clear conclusions.

7.1 Conclusions drawn from the project results

The changes detected in smoke alarms that are caused by ageing – gathering of dirt, changes in smoke sensitivity, weakening volume levels – and their impact on alarm function support the need for replacing smoke alarms. At the latest, a smoke alarm should be replaced when it is ten years old, unless the manufacturer has marked a shorter operating life on the device.

Dirt may increase or decrease the sensitivity of the smoke alarm. Excessive sensitivity increases the risk of false alarms, increasing the risk of the smoke alarm being removed or disabled. If a smoke alarm becomes less sensitive and the alarm time is increased by just a few minutes, it will make the smoke alarm considerably slower in detecting a fire, thus reducing escape time and and/or time to begin extinguishing the fire.

The purpose of a smoke alarm is to detect a fire early and to sound a sufficiently loud alarm to warn people. When the volume level of a smoke alarm is reduced due to factors caused by ageing, there is no sufficient certainty that a person who is sleeping, or living next door, will hear the sound of the smoke alarm.

Another factor that supports the replacement of smoke alarms is the ageing of electronic components.

Statistically, the most common reason for an inoperative smoke alarm is human action, meaning that there is no smoke alarm, the battery is missing, or the battery is not working. Regular testing of the functioning of the smoke alarm and replacing the battery are vital measures in making sure that the smoke alarm works.

7.2 Evaluation of the project and further action

As no corresponding studies investigating the smoke sensitivity of old smoke alarms was found, the information generated in the project is valuable. The results provide good grounds for the need to replace smoke alarms. As this was the first study of its kind, several issues were raised during the analysis of the test results that warrant further studies:

- the impact of age on the functioning of optical smoke alarms through a larger sample, as optical smoke alarms have dominated the market for the last decade
- the impact of the detection type of optical smoke alarms (scattered light or transmitted light) on ageing
- more detailed study on the connection between the location of the smoke alarm, such as a holiday home, and corrosion and the gathering of dirt.
- more detailed measuring of the volume levels of old smoke alarms and comparison with the volume levels of new smoke alarms.

A further study, focusing on the issues mentioned above, is likely to be conducted within the next few years.

The results of this project will be utilised in safety communication and accident investigation.

References

1. Hyttinen, V., Tolonen, P., Väisänen, T. 2008. Palofysiikka. 3rd edition, Finnish National Rescue Association
2. Hassinen, M., et al. 2017. Modernien kodinkoneiden palokäyttäytyminen ja sammutustekniikka, Publication of the Emergency Services College, Finland, B series, Research reports, 4/2017
http://info.smedu.fi/kirjasto/Sarja_B/B4_2017.pdf
3. Christian Sesseng (SINTEF NBL as): Røykvarslere for bruk i bolig. Kartlegging av forskningsfront
<http://www.risefr.no/media/publikasjoner/upload/nbl-a12136.pdf>
4. Jackson, M., et al., 2010. *Evaluation of Fire-Safety Programs that use 10-Year Smoke Alarms*. Journal of Community Health. **35**(5): p. 543-548
<https://www.ncbi.nlm.nih.gov/pubmed/20177753>
5. https://www.gov.uk/government/uploads/system/uploads/attachment_data/file/610304/fire-statistics-data-tables-fire0702.xlsx
6. <http://www.nfpa.org/~media/files/news-and-research/fire-statistics/fire-protection-systems/ossmokealarms.pdf?la=en>

Appendix 1

Information on the smoke alarm

Thank you for your donation and participation in the ageing study on smoke alarms. Please complete the form and return it and the smoke alarm to the contact person in your organisation [*name*].

Location:

Apartment	<input type="checkbox"/>
Terraced/semi-detached house	<input type="checkbox"/>
Detached house	<input type="checkbox"/>
Holiday home	<input type="checkbox"/>

Is there a fireplace in your home/holiday home?

yes	<input type="checkbox"/>
no	<input type="checkbox"/>

If the smoke alarm was in a holiday home and the building is not heated in the winter, were the smoke alarm and the battery stored in a warm place during the winter?

yes	<input type="checkbox"/>
no	<input type="checkbox"/>

The smoke alarm has undergone the following maintenance:

the test button was pressed regularly

Underline the best alternative:

Once a month / once a year / between once a month and once a year

replace the battery

replace the battery and
press the test button

light cleaning with a vacuum cleaner

no maintenance

Contact information (voluntary):

Name _____

Tel. _____

Email _____

For further information, please contact: Senior Officer Karoliina Meurman, karoliina.meurman@tukes.fi, tel. +358 29 5052 651